

Novia
A Division of C&P

Represented By:



Phone: (860) 530-1580

PROJECT: _____

CUSTOMER: _____

NPW 516

NEOPRENE - WAFFLE
PAD
NPW 516 7/28/16

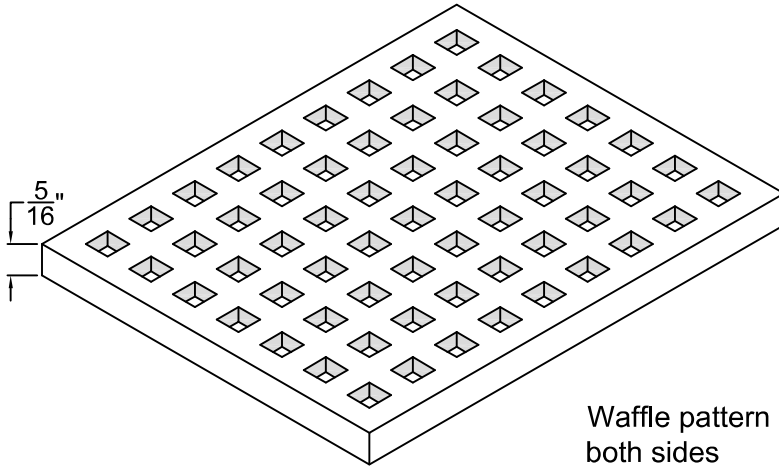

Waffle pattern on both sides

MODEL	MAX CAPAC. (LBS)	SIZE (IN)
NPW 516 1818	9,720	18 X 18 X 5/16
NPW 516 1212	4,320	12 X 12 X 5/16
NPW 516 0808	1,920	8 X 8 X 5/16
NPW 516 0606	1,080	6 X 6 X 5/16
NPW 516 0404	480	3 X 3 X 5/16
NPW 516 0303	270	4 X 4 X 5/16
NPW 516 0202	120	2 X 2 X 5/16
Any size available		

Material: Neoprene - 45 Duro
Maximum Loading: 30 lbs. / sq. in.
Working Range: 15 to 30 lbs. / sq. in.

NPW-516 Indicates one layer of pad.



NPW-516-P Indicates one layer of pad with steel load plate.



NPW-516-2S Indicates two layers of pad with galvanized shim.

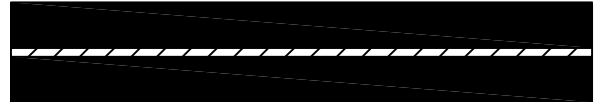

NPW-516-2P Indicates two layers of pad with steel load plate & shim.

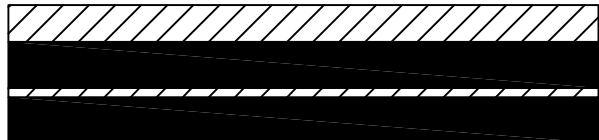

Features:

- * "Waffle Pad" design with built-in suction cups on both sides
- * No bolting required
- * Easy to cut

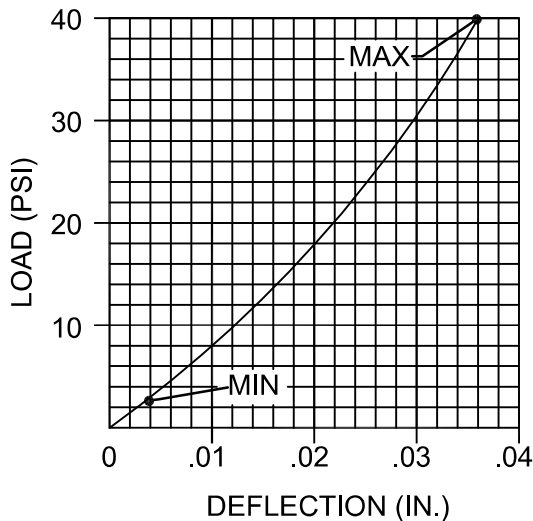

CERTIFICATION DATA

BY:

DATE:

DWG#:

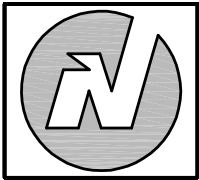

Novia
A Division of C&P

Represented By:



Phone: (860) 530-1580

PROJECT: _____

CUSTOMER: _____

NPR 38

NATURAL RUBBER
PAD-RIBBED
NPR 38 7/28/16

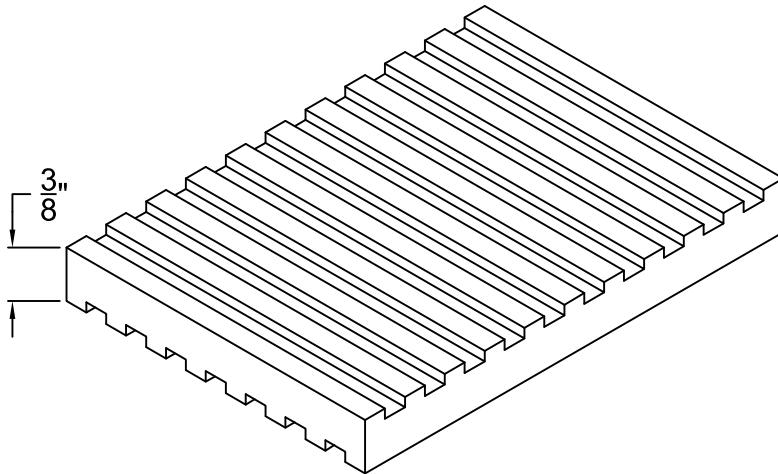

MODEL	MAX CAPAC. (LBS)	SIZE (IN)
NPR 38 1818	19,440	18 X 18 X 3/8
NPR 38 1212	8,640	12 X 12 X 3/8
NPR 38 0808	3,840	8 X 8 X 3/8
NPR 38 0606	2,160	6 X 6 X 3/8
NPR 38 0404	960	3 X 3 X 3/8
NPR 38 0303	540	4 X 4 X 3/8
NPR 38 0202	240	2 X 2 X 3/8
Any size available		

Material: Natural Rubber 80 Duro
Maximum Loading: 60 lbs. / sq. in.
Working Range: 30 to 60 lbs. / sq. in.

NPR-38 Indicates one layer of pad.



NPR-38-P Indicates one layer of pad with steel load plate.

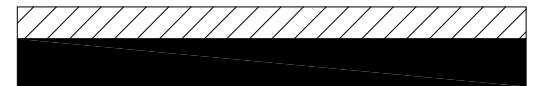

NPR-38-2S Indicates two layers of pad with galvanized shim.



NPR-38-2P Indicates two layers of pad with steel load plate & shim.

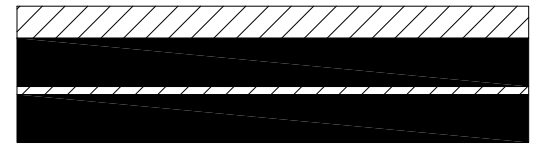

Features:

- * Alternate High-Low rib construction
- * No bolting required
- * Easy to cut

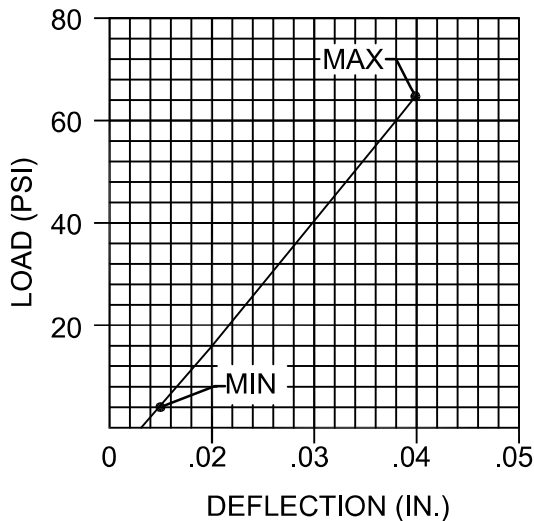

CERTIFICATION DATA

BY:

DATE:

DWG#:

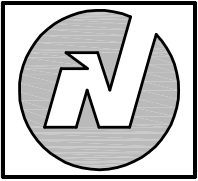

Novia
A Division of C&P

Represented By:



Phone: (860) 530-1580

PROJECT: _____

CUSTOMER: _____

NPW 75

NEOPRENE - WAFFLE
PAD
NPW 75 7/28/16

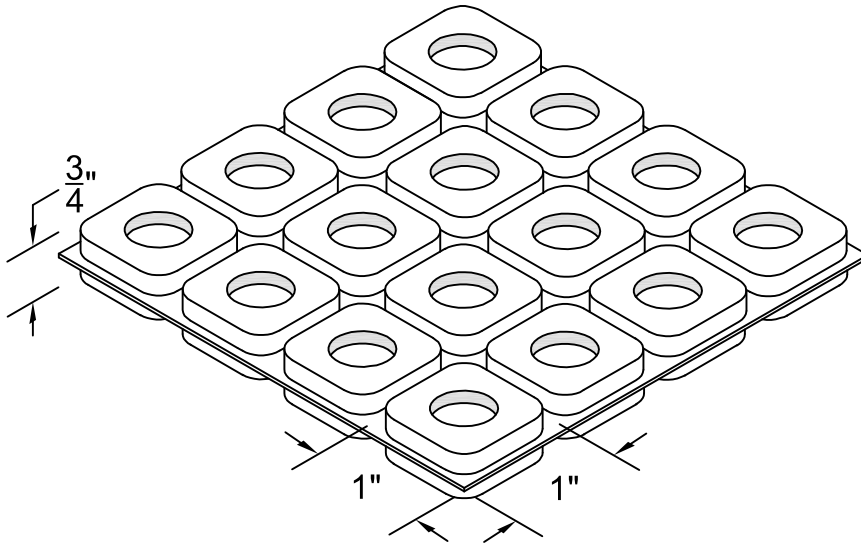

MODEL	MAX CAPAC. (LBS)	SIZE (IN)
NPW 75 1818	19,440	18 X 18 X 3/4
NPW 75 1212	8,640	12 X 12 X 3/4
NPW 75 0808	3,840	8 X 8 X 3/4
NPW 75 0606	2,160	6 X 6 X 3/4
NPW 75 0404	960	4 X 4 X 3/4
NPW 75 0202	240	2 X 2 X 3/4

Any size available in 1" increments

Material: High Quality Ozone & Water Resistant 55 Duro Elastomer Blend
 Maximum Loading: 60 lbs. / sq. in.
 Working Range: 15 to 55 lbs. / sq. in.

NPW-75 Indicates one layer of pad.

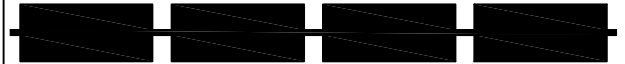

NPW-75-P Indicates one layer of pad with steel load plate.

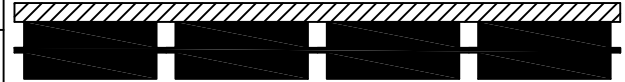

NPW-75-2S Indicates two layers of pad with galvanized shim.

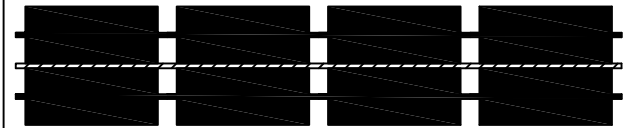

NPW-75-2P Indicates two layers of pad with steel load plate & shim.

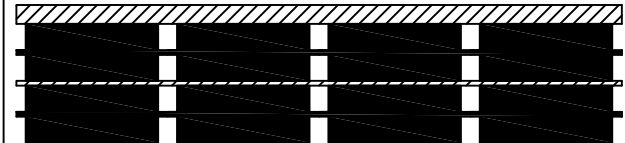

Features:

- * "Waffle Pad" design with built-in suction cups on both sides
- * No bolting required
- * Easy to cut

Recommended Loading

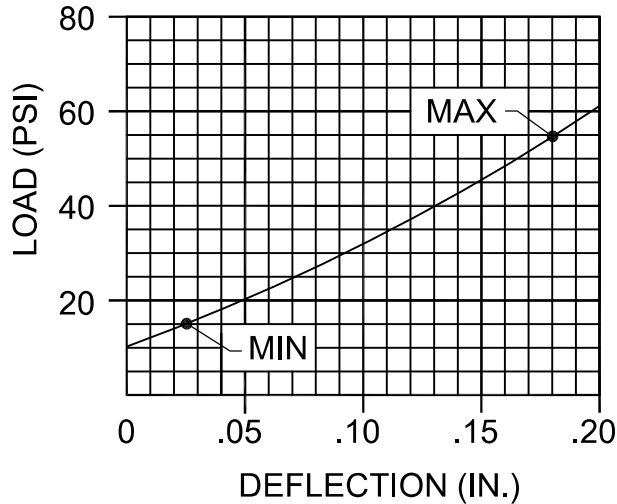

CERTIFICATION DATA

BY:

DATE:

DWG#: